



Cadet Pan-American Cup Santo Domingo 2019

(DOM Santo Domingo, 5 May 2019)

-44 kg

3 Judoka

			1	2	3		
1	AVILA, Keidy	DOM		+	+	2 (20)	
2	DE LA CRUZ, Franchesca Maria	DOM	-		-	0 (0)	
3	ASENCIO CASTILLO, Cielo Estrella	DOM	-	+		1 (10)	

1	AVILA, Keidy	DOM	1	AVILA, Keidy	DOM
2	DE LA CRUZ, Franchesca Maria	DOM		10 / 00	0:34

1	AVILA, Keidy	DOM	2	AVILA, Keidy	DOM
3	ASENCIO CASTILLO, Cielo Estrella	DOM		10 s1 / 00	1:06

2	DE LA CRUZ, Franchesca Maria	DOM	3	ASENCIO CASTILLO, Cielo Estrella	DOM
3	ASENCIO CASTILLO, Cielo Estrella	DOM		00 s3 / 10 s1	2:39

1. AVILA, Keidy DOM

2. ASENCIO CASTILLO, Cielo Estrella DOM



Cadet Pan-American Cup Santo Domingo 2019

(DOM Santo Domingo, 5 May 2019)

-48 kg

7 Judoka

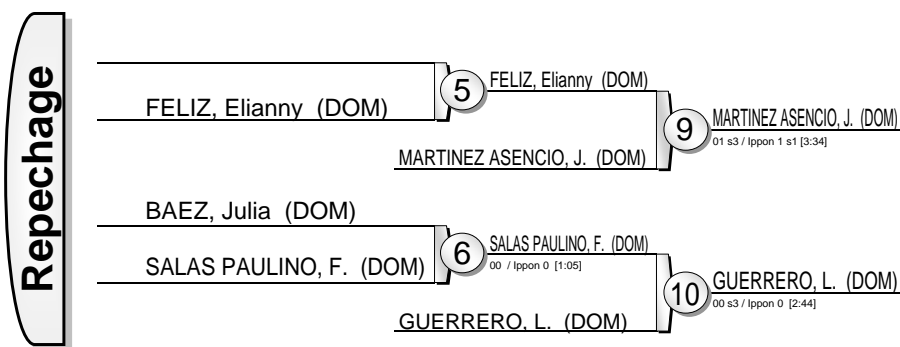
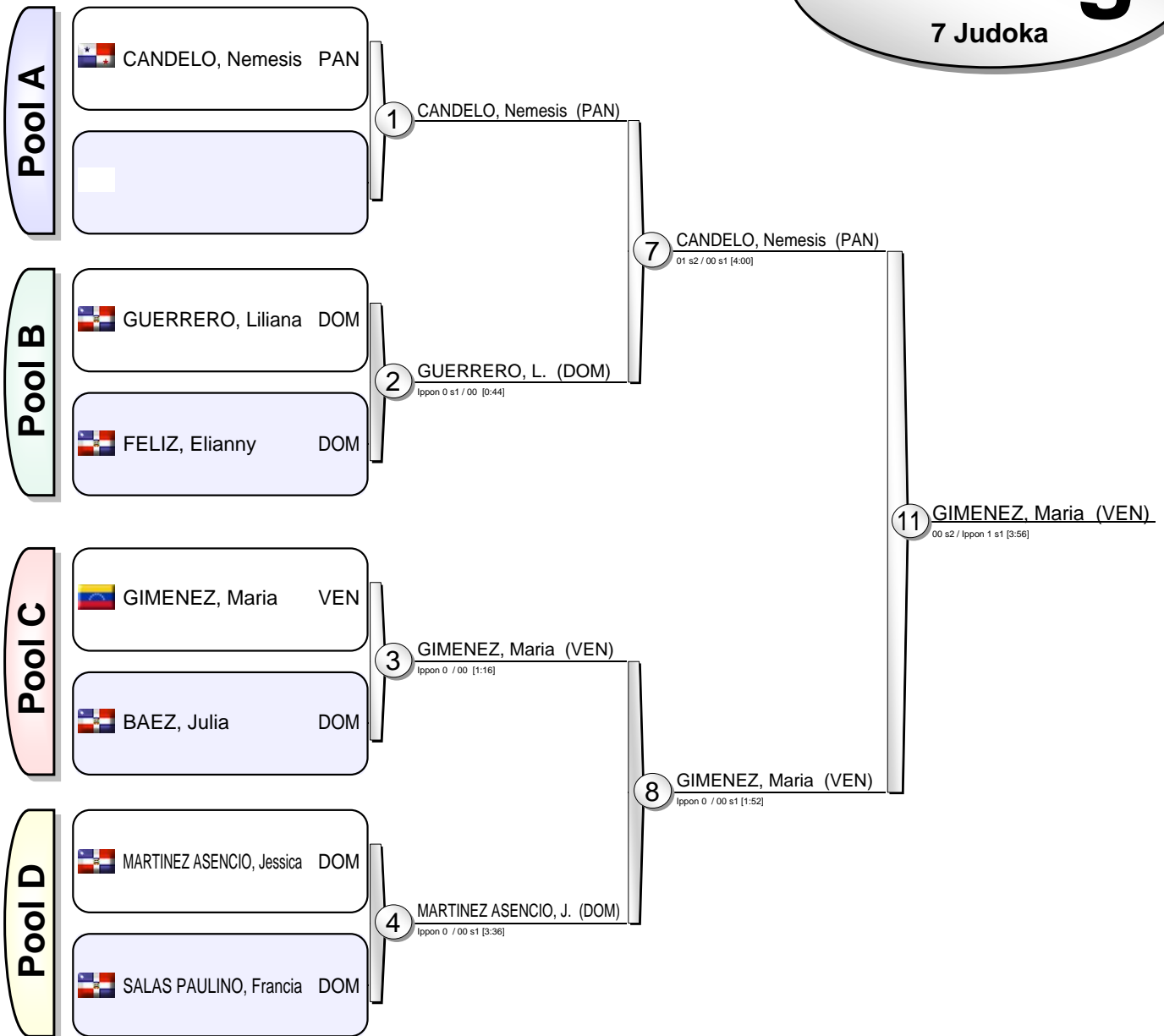

Results

- GIMENEZ, Maria VEN
- CANDELO, Nemesis PAN
- MARTINEZ ASENCIO, Jessica DOM
- GUERRERO, Liliana DOM
- FELIZ, Elianny DOM
- SALAS PAULINO, Francia DOM
-
- BAEZ, Julia DOM

Gadet Pan-American Cup Santo Domingo 2019

(DOM Santo Domingo, 5 May 2019)

-52 kg

4 Judoka

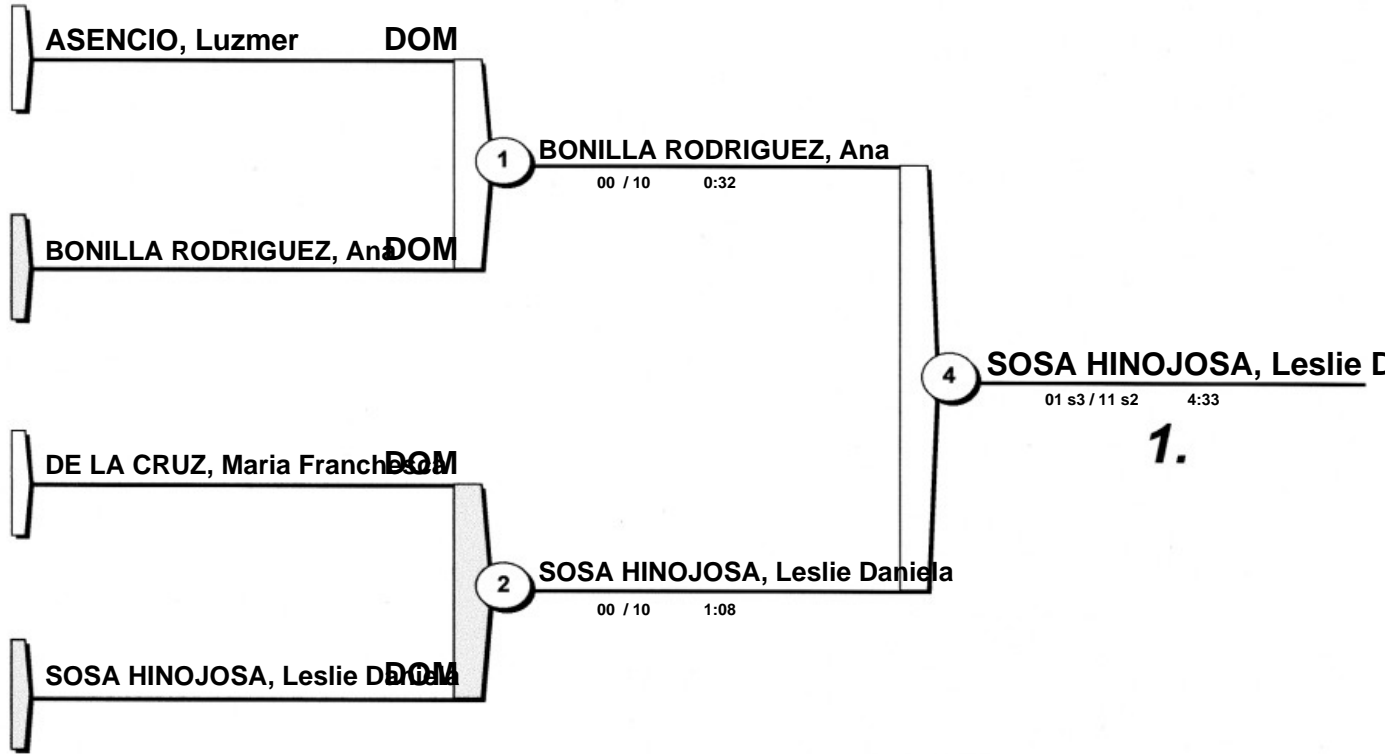

1.

3.

1. SOSA HINOJOSA, Leslie Daniela (DOM)
2. BONILLA RODRIGUEZ, Ana (DOM)
3. ASECIO, Luzmer (DOM)



Cadet Pan-American Cup Santo Domingo 2019

(DOM Santo Domingo, 5 May 2019)

-57 kg

7 Judoka

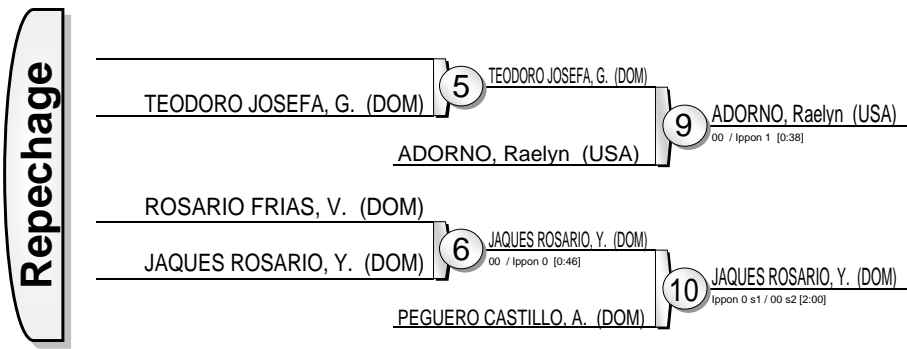
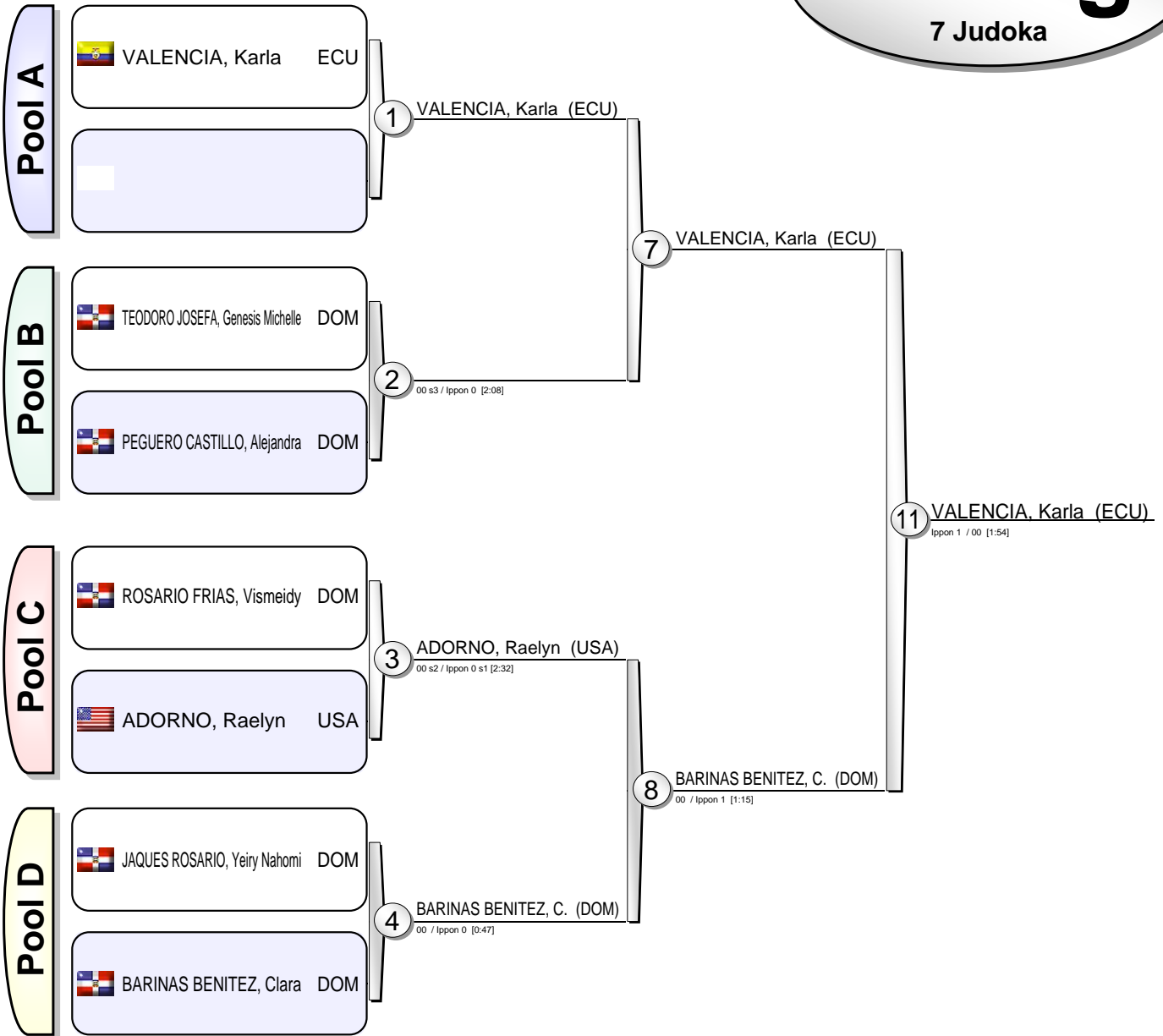

Results		
1.	VALENCIA, Karla	ECU
2.	BARINAS BENITEZ, Clara	DOM
3.	ADORNO, Raelyn	USA
3.	JAQUES ROSARIO, Yeiry Nahomi	DOM
5.	TEODORO JOSEFA, Genesis Michelle	DOM
5.	PEGUERO CASTILLO, Alejandra	DOM
7.		
7.	ROSARIO FRIAS, Vismeidy	DOM



Cadet Pan-American Cup Santo Domingo 2019

(DOM Santo Domingo, 5 May 2019)

-63 kg

6 Judoka

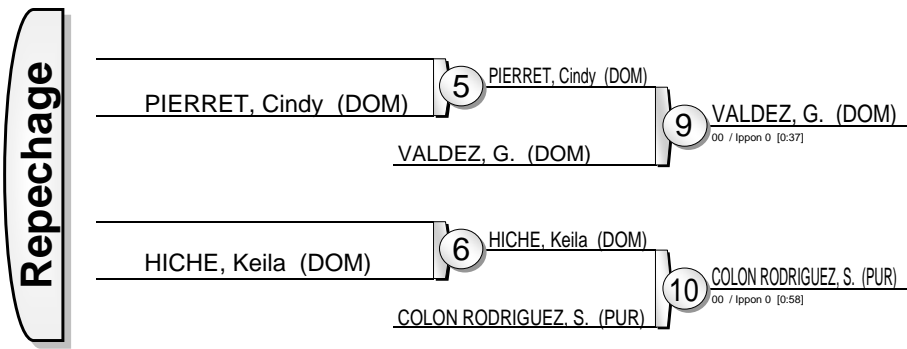
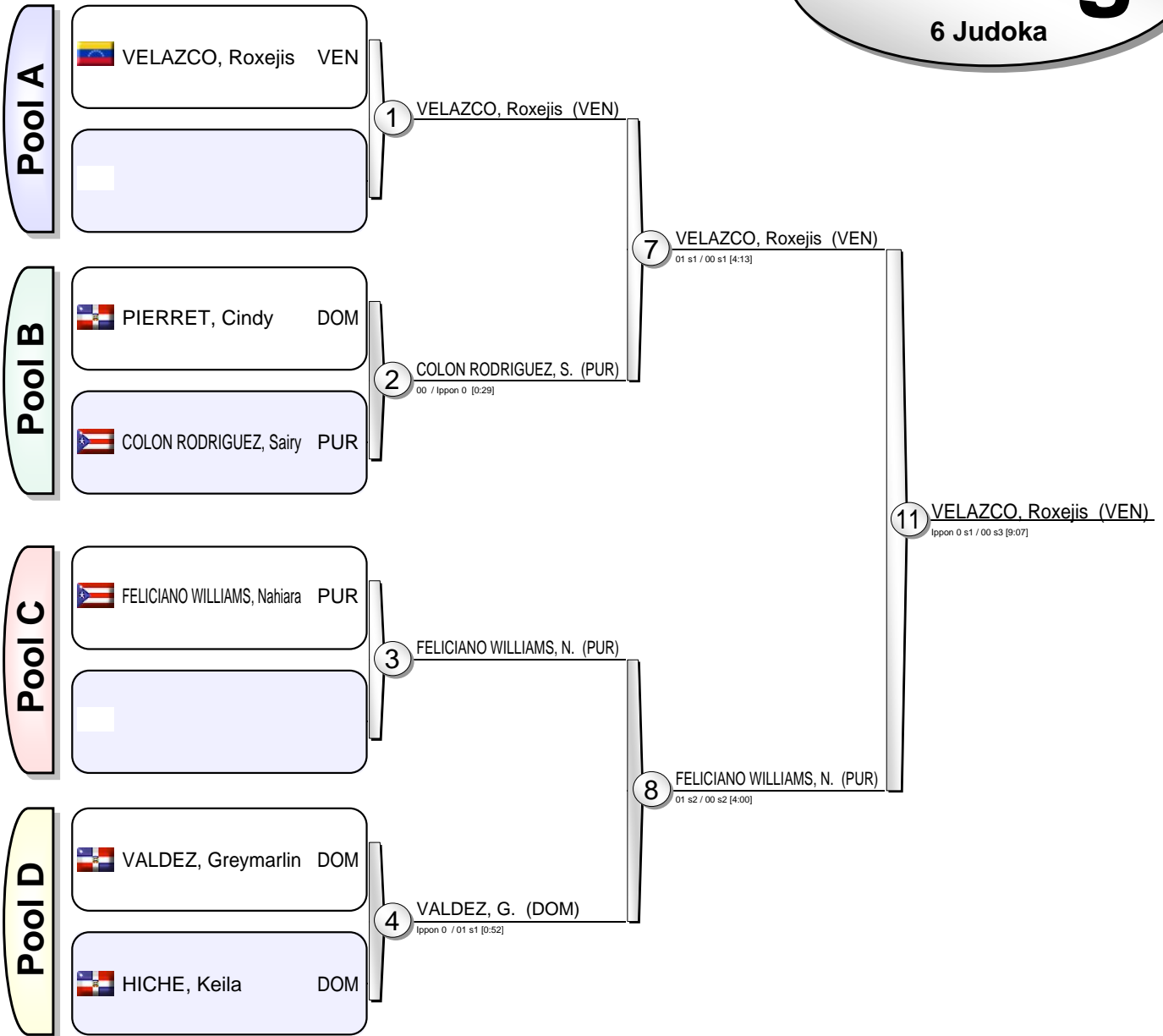

Results		
1.	VELAZCO, Roxejis	VEN
2.	FELICIANO WILLIAMS, Nahara	PUR
3.	VALDEZ, Greymarlin	DOM
3.	COLON RODRIGUEZ, Sairy	PUR
5.	PIERRET, Cindy	DOM
5.	HICHE, Keila	DOM
7.		
7.		



Cadet Pan-American Cup Santo Domingo 2019

(DOM Santo Domingo, 5 May 2019)

-70 kg

3 Judoka

		1	2	3		
1	RODRIGUEZ SANTANA, Rohanny DOM		+	+	2 (20)	
2	FRIAS JAVIER, Nayelis Carolina DOM	-		+	1 (10)	
3	AMADOR PINEDA, Scarlin Paola DOM	-	-		0 (0)	

1	RODRIGUEZ SANTANA, Rohanny DOM	1	RODRIGUEZ SANTANA, Rohanny DOM
2	FRIAS JAVIER, Nayelis Carolina DOM		11 / 00 s3 3:01

1	RODRIGUEZ SANTANA, Rohanny DOM	2	RODRIGUEZ SANTANA, Rohanny DOM
3	AMADOR PINEDA, Scarlin Paola DOM		10 / 00 1:08

2	FRIAS JAVIER, Nayelis Carolina DOM	3	FRIAS JAVIER, Nayelis Carolina DOM
3	AMADOR PINEDA, Scarlin Paola DOM		10 s1 / 00 2:01

1. RODRIGUEZ SANTANA, Rohanny DOM
2. FRIAS JAVIER, Nayelis Carolina DOM

Gadet Pan-American Cup Santo Domingo 2019

(DOM Santo Domingo, 5 May 2019)

+70 kg

4 Judoka

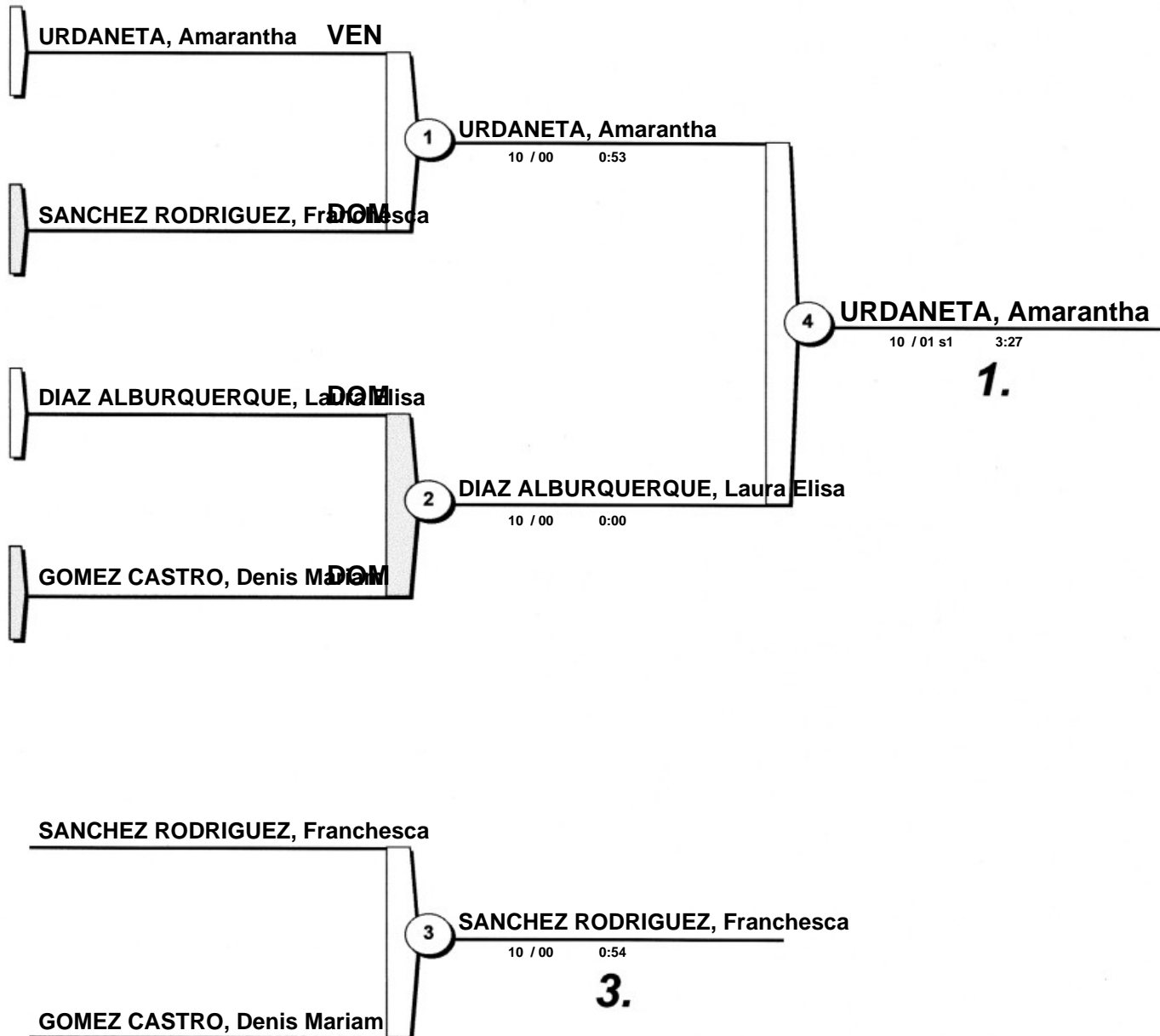

1. URDANETA, Amarantha VEN
2. DIAZ ALBURQUERQUE, Laura Elisa DOM
3. SANCHEZ RODRIGUEZ, Franchesca DOM